

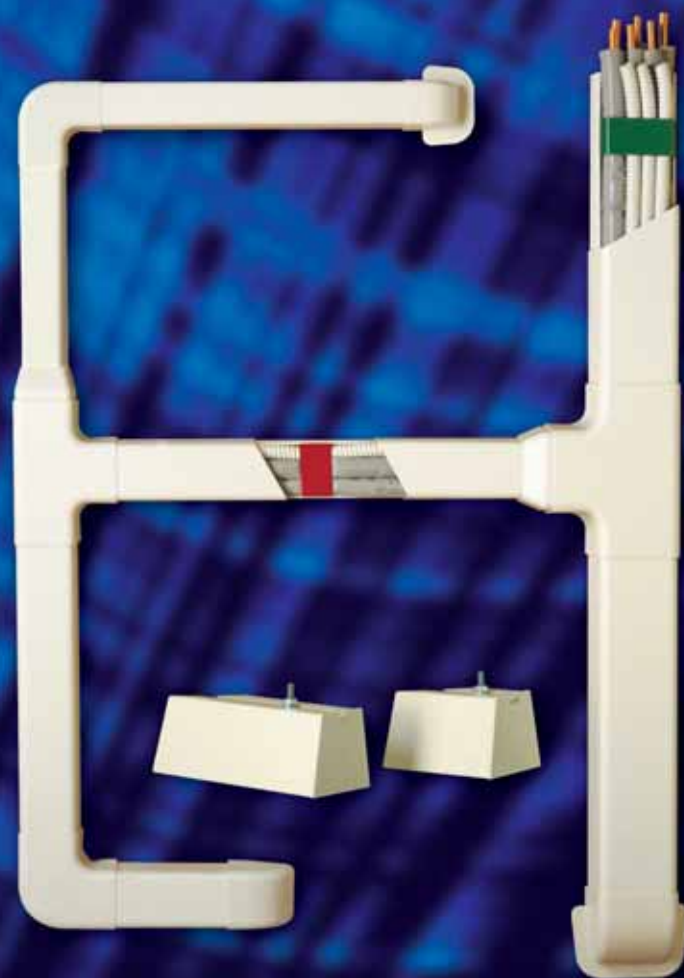

# PlastiDuct™

PVC Ducting System for Line Sets and Piping

*Attractive and Stylish Solution  
for Hiding Tubing and Pipe*



- **High Quality PVC**
- **Quick & Easy Installation**
- **UV & Shock Resistant**
- **Paintable PVC to Match it's Surroundings**
- **Non-flammable UL94**
- **Temperature Acceptability -4° to 140°**



## PlastiDuct™

PVC Ducting System for Line Sets and Piping

*Made in Italy exclusively for:*

**International Refrigeration Products**  
11325 Nations Ford Road  
Charlotte, NC 28134 USA  
Phone: 704.504.8590  
Fax: 704.504.3023

## PlastiDuct is quick and easy to install

- Screw base into wall with screw anchors using the pre-drilled holes.
- Hold tubing into base with the specially designed colored clips.
- Place PlastiDuct cover and fittings over base and tubing.
- Use additional screws and caulk where necessary. **Job done!**

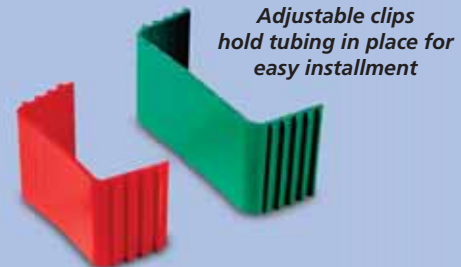
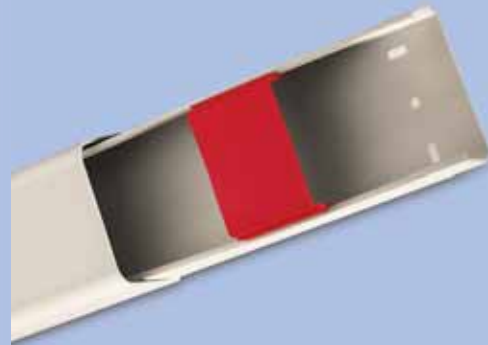
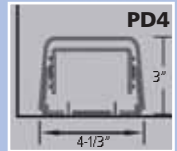
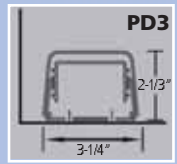

### PlastiDuct

Product	Size (inches) W x D x L	Packaging
PD3	3-1/4 x 2-1/3 x 6-1/2	8 pcs / 52-1/2 ft.
PD4	4-1/3 x 3 x 6-1/2	4 pcs / 26-1/3 ft.

### Clips

Product	Color	Packaging
PDC3	Red – For use with PD3	30
PDC4	Green – For use with PD4	20

### End Cap

Product	Packaging
PDECap3	For use with PD3
	9

### Corner Wall Elbow

Product	Packaging
PDWE3	For use with PD3
	6
PDWE4	For use with PD4
	4

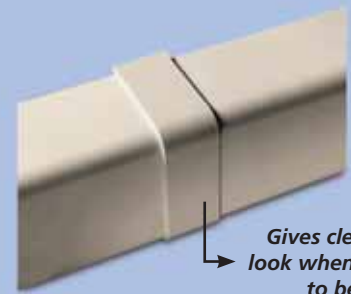

Gives clean professional look when PlastiDuct needs to be connected

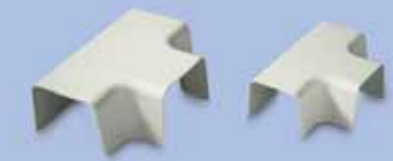

### Cover Joints

Product	Packaging
PDCJ3	For use with PD3
	30
PDCJ4	For use with PD4
	20

### Internal Corners

Product	Packaging
PDIC3	For use with PD3
	6
PDIC4	For use with PD4
	4

### Wall Passage

Product	Packaging
PDWP3	For use with PD3
	8
PDWP4	For use with PD4
	8

### "T"

Product	Packaging
PDT3	For use with PD3
	4
PDT4	For use with PD4
	2

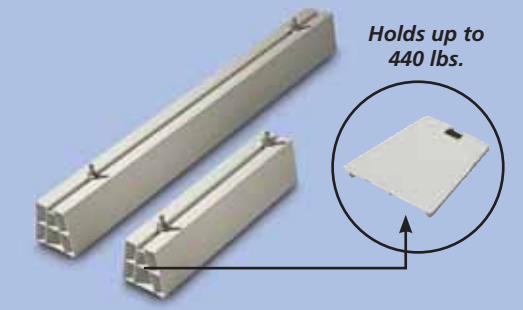

### External Corners

Product	Packaging
PDEC3	For use with PD3
	9
PDEC4	For use with PD4
	6

### Flat Curve

Product	Packaging
PDFC3	For use with PD3
	8
PDFC4	For use with PD4
	6

### Reducers

Product	Packaging
PDR4	For use with PD4
	8

### Floor Supports

Product	Size (inches) W x D x L	Packaging
PDF18	18 x 4 x 4	24
PDF39	39 x 4 x 4	4
PDFC	Floor Support Caps	24